

NJK-02 - Location and Mounting:



Table of Contents

#1 - Right Angle wo/Turning Vanes Mounting	Page 2	#16 - Single Take-Off Branch Mounting	Page 6
#2 - Right Angle w/Turning Vanes Mounting	Page 2	#17 - Duct Transition Mounting	Page 6
#3 - Right Angle w/Rounded Elbow Mounting	Page 2	#18 - Dual Outside Air Inlet Mounting	Page 6
#4 - Inward Tapered Transition Mounting	Page 2	#19 - Right Angle Outside Air Inlet Mounting	Page 7
#5 - 90 deg. Square Duct Mounting	Page 3	#20 - Right Angle Outside Air Inlet Mounting	Page 7
#6 - 90 deg. Tapered Duct Mounting	Page 3	#21 - Air Handler Inlet / Outlet Mounting	Page 7
#7 – Tapered “Upsized” Duct Mounting	Page 3	#22 - Air Handler Inlet Mounting	Page 8
#8 - “Y” Duct Connection (outward) Mounting	Page 3	#23 - Air Handler Inlet Mounting	Page 8
#9 - “Y” Duct Connection (inward) Mounting	Page 3	#24 - Centrifugal Fan Plenum Mounting	Page 9
#10 - Dual Input 90 Deg. Duct Mounting	Page 4	#25 - Right Angle Plenum Mounting	Page 9
#11 - Tapered “Upsized” Duct Mounting	Page 4	#26 - Angled Duct Inlet Mounting	Page 10
#12 - Single Input-Dual Output Mounting	Page 4	#27 - Tapered Duct Inlet Mounting	Page 10
#13 - Plug Fan Plenum Mounting	Page 5	#28 - Tapered Duct Inlet Mounting	Page 10
#14 - In-Line Fan Duct Mounting	Page 5	#29 - Tapered Supply Plenum	Page 10
#15 - Outside Air Inlet Mounting	Page 5	#30 - Multiple Take-Off Branch Mounting	Page 11

All duct diameters listed for rectangular ducts will use an Equivalent Duct Diameter (EDD) (see formula listed below).

"D" is equal to Equivalent Duct Diameter (EDD). $EDD = \sqrt{4ab/\pi}$

NJK-02 - Location and Mounting: General

Right Angle wo/Turning Vanes Mounting

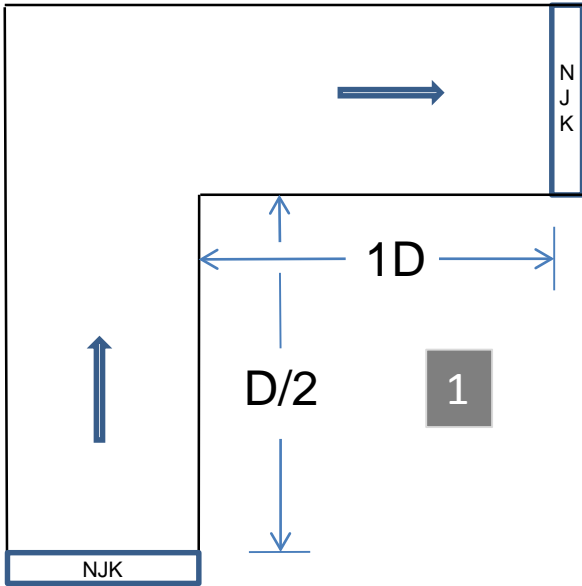

Right Angle w/Turning Vanes Mounting

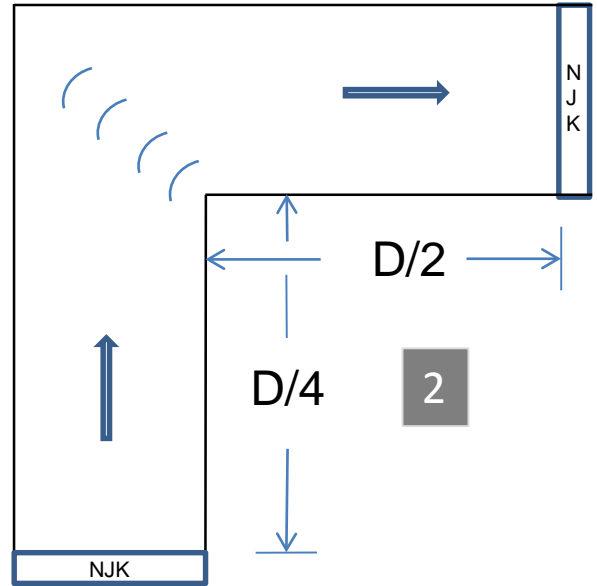

Right Angle w/Rounded Elbow Mounting

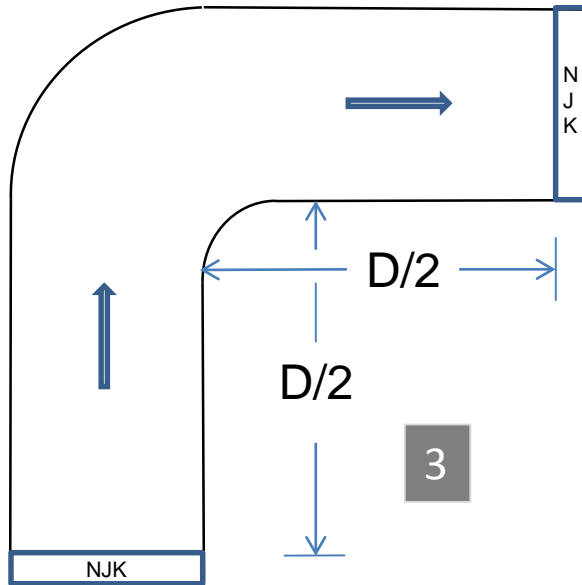

Inward Tapered Transition Mounting

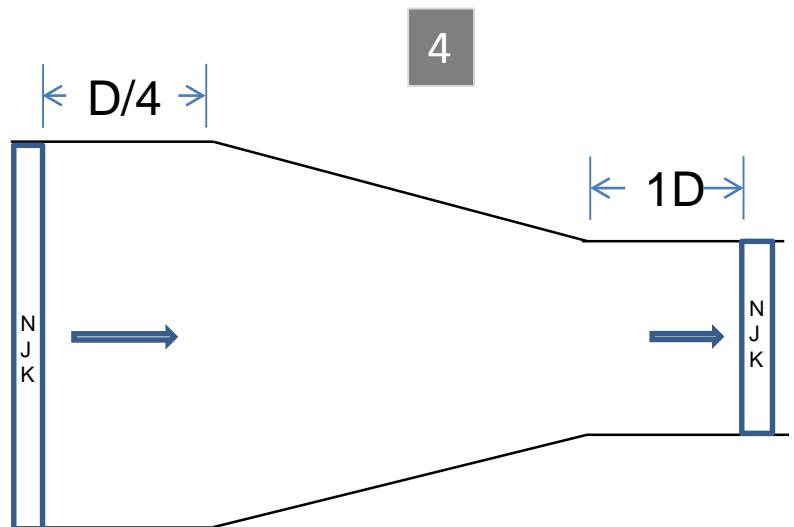

NJK-02 - Location and Mounting: General

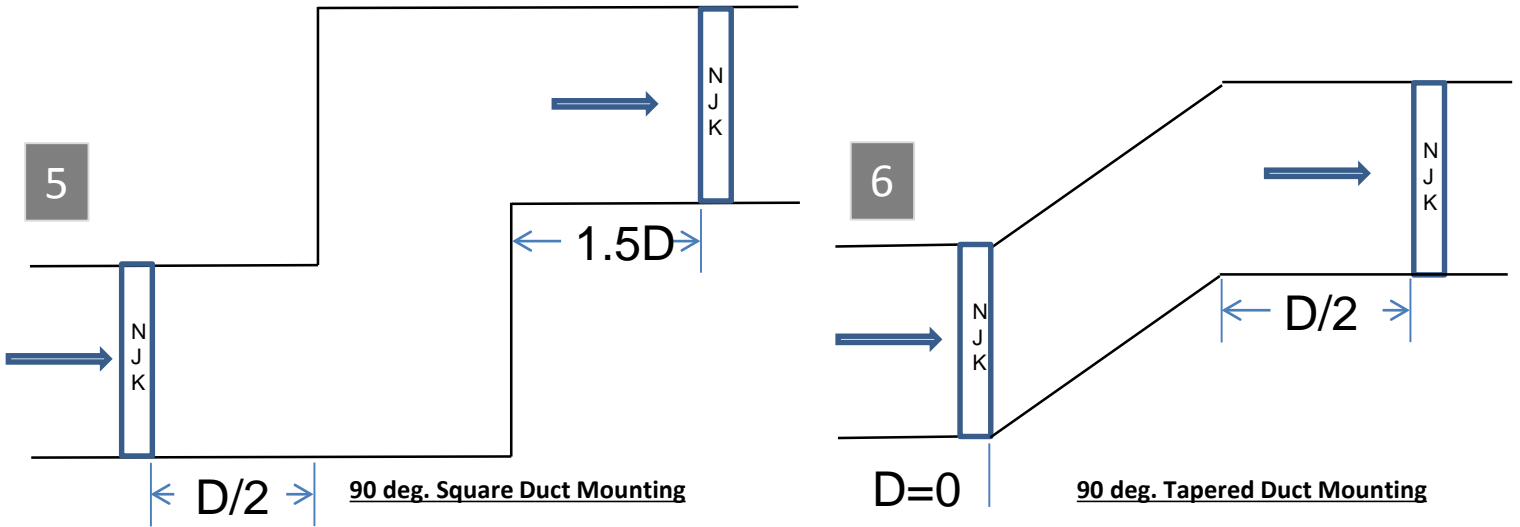

Tapered "Upsized" Duct Mounting

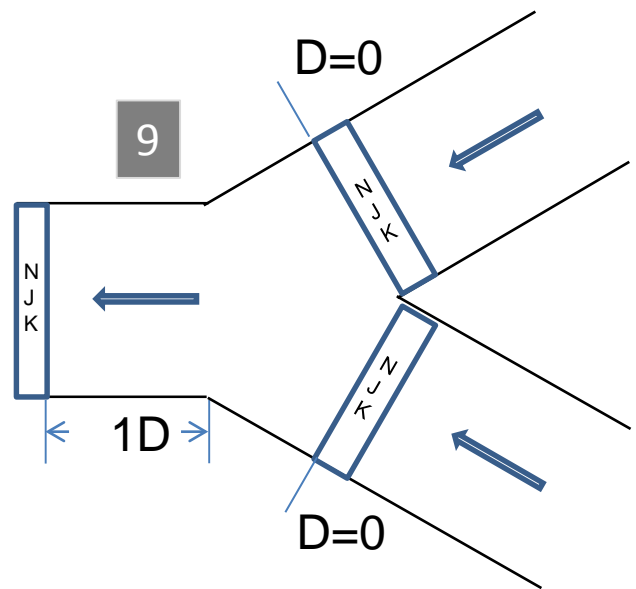
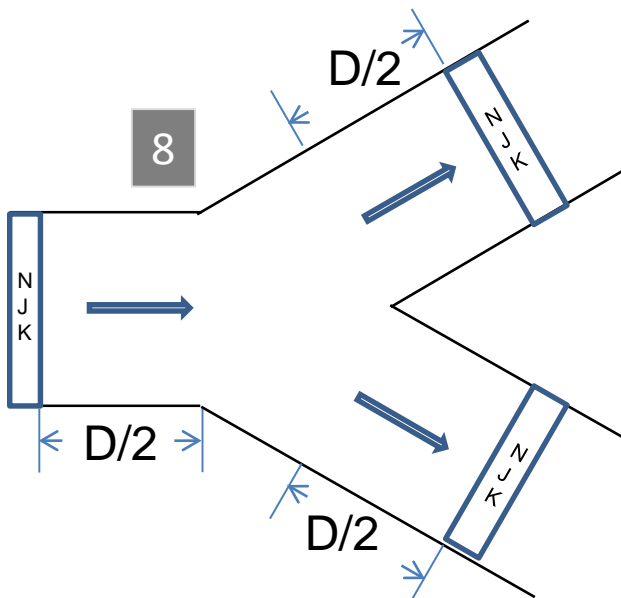
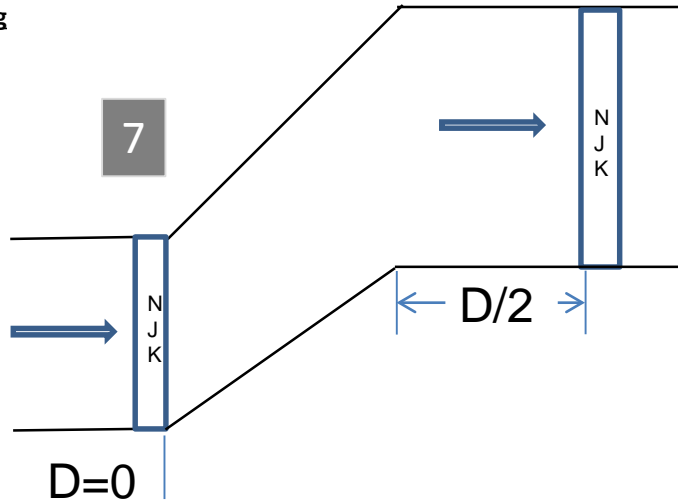

"Y" Duct Connection (outward) Mounting

"Y" Duct Connection (inward) Mounting

NJK-02 - Location and Mounting: General

10

Dual Input 90 Deg. Duct Mounting

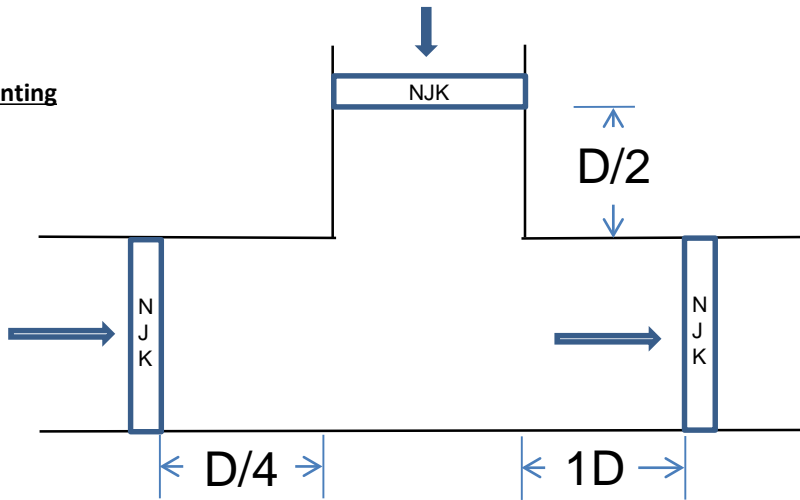

11

Tapered "Upsized" Duct Mounting

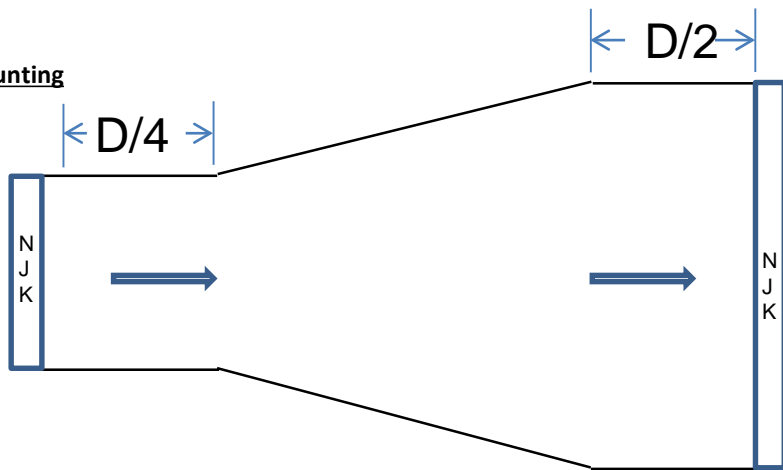

12

Single Input-Dual Output Mounting

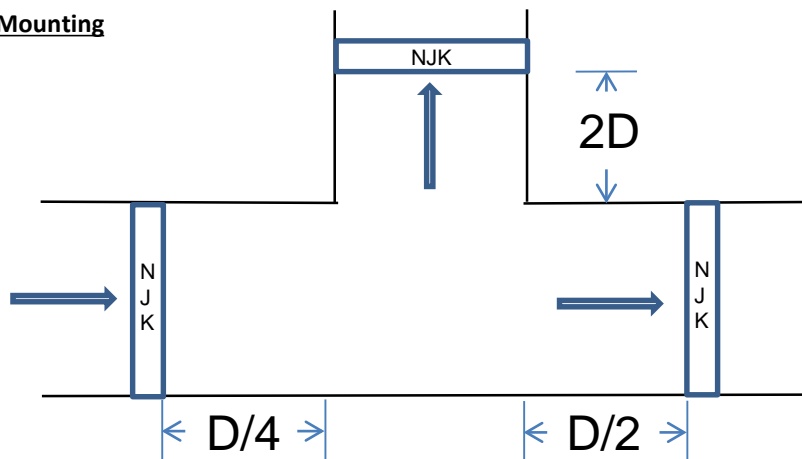

NJK-02 - Location and Mounting: Examples

Plug Fan Plenum Mounting

In a **supply plenum** with “Plug” or Plenum Centrifugal Fans the air is distributed evenly throughout the entire supply plenum. In this application the NJK Sensor Flow Frame can be installed with little or no ductwork leading into the NJK Sensor Flow Frame

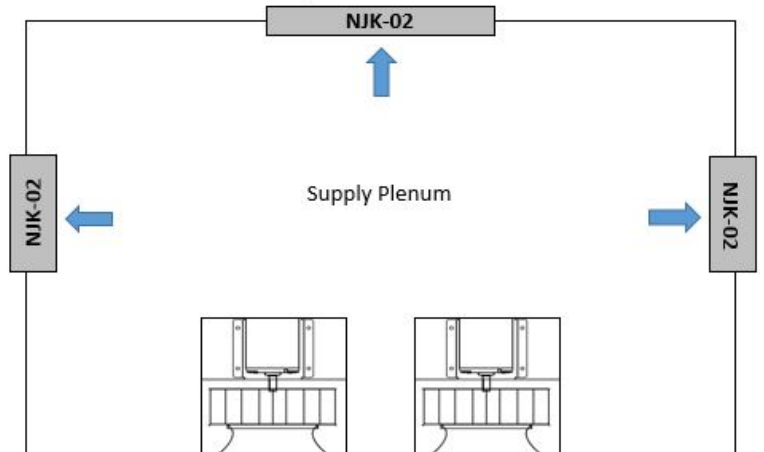

13

In-Line Fan Duct Mounting

With an in-line fan the NJK Sensor Flow Frame can NOT be installed without some lengths of straight ductwork leading into the NJK Flow Frame. The NJK Sensor Flow Frame will need to be installed further downstream or upstream in straight duct lengths.

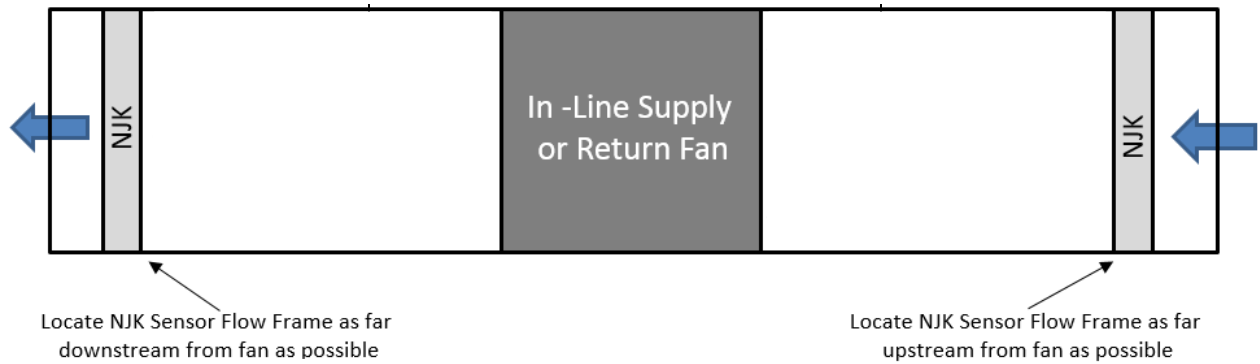

14

Outside Air Inlet Mounting

Mount the NJK Sensor Flow Frame inside of a rain hood or outside air inlet opening to assure that the factory system dynamics of the rooftop or packaged unit are not altered.

NJK Flow Frames mounted on the opening face of an inlet should have a 1 inch to 1-1/2 inch sheet metal angle piece added to allow uniform flow into the inlet chamber of the NJK Sensor.

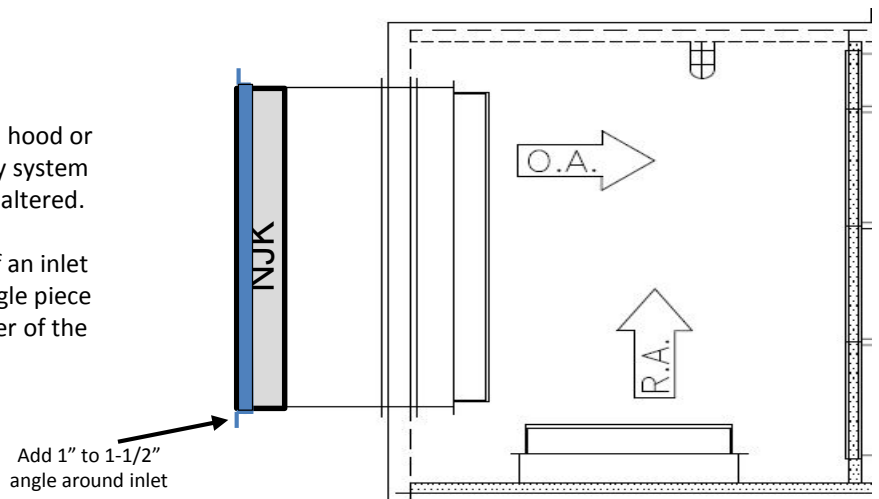

15

NJK-02 - Location and Mounting: Examples

Single Take-Off Branch Mounting

In the Single Take-Off mounting installation to the right the NJK Sensor Flow Frame is to be mounted in a duct take-off from the main plenum. This can be in an Exhaust, Outside, or Return Air Plenum

Mounting the NJK Flow Frame **even with the face of the duct take-off** allows for air to enter and exit the NJK Sensor Flow Frame with all areas of the Sensor Flow Frame being exposed to the flow of air. If this mounting is not achievable mount the NJK Flow Frame a minimum of 2 duct diameters downstream.

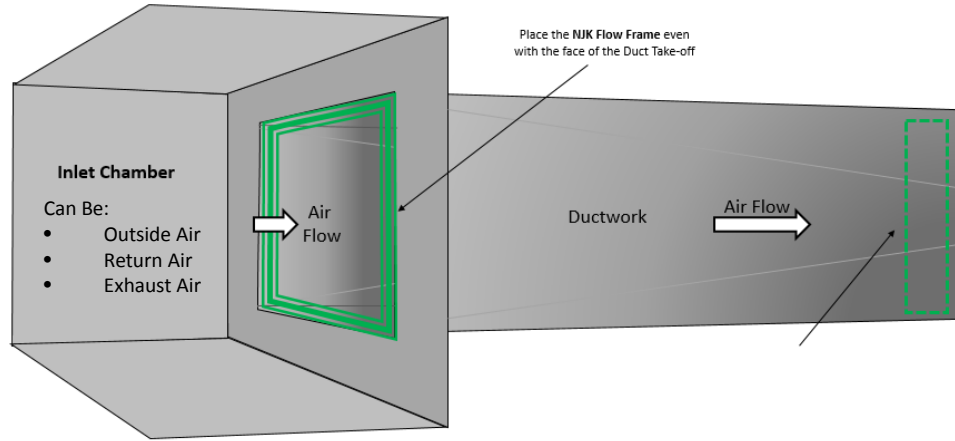

16

Duct Transition Mounting

Duct transitions that have the NJK Flow Frame mounted on the expanded duct section after a step up transition must be avoided as the flowing air can bypass the NJK Sensor and give a reduced flow reading.

Mount the NJK Flow Frame in the smaller sized duct prior to a step up transition or duct flare.

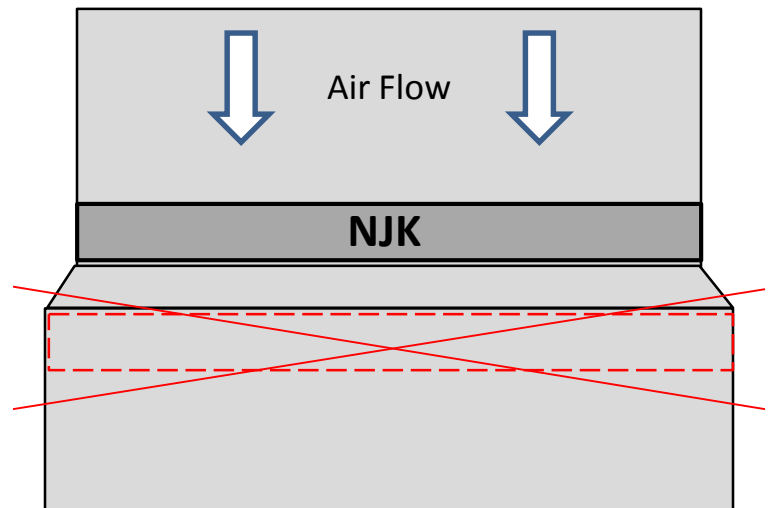

17

Dual Outside Air Inlet Mounting

Outside air minimum and maximum dampers located in a shared plenum can allow minimum air flow to pass through maximum air flow sensor when maximum dampers are closed causing a false reading through the maximum air sensor

To alleviate this install sheet metal extension sleeves on both the minimum and maximum outside damper inlets to direct the air into the proper sensor and to eliminate false readings through sensors on unopened dampers.

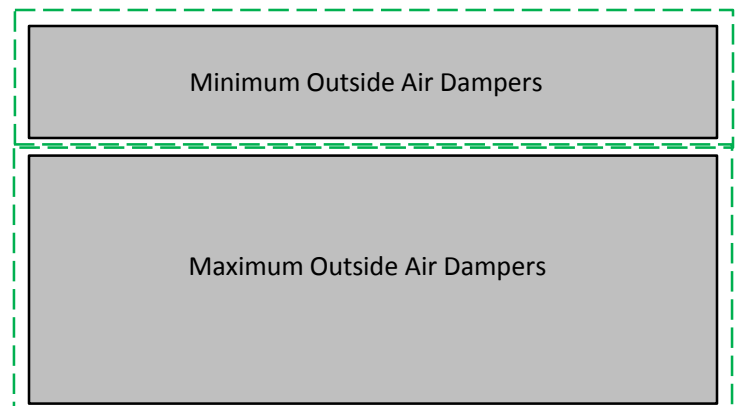

Install sheet metal sleeves extending 8" to 12" outward from NJK Flow Frame

18

NJK-02 - Location and Mounting: Examples

Right Angle Outside Air Inlet Mounting

In the mounting installation to the right the NJK Sensor Flow Frame is to be mounted in an exterior wall inlet directly after the inlet rain louvers. This installation allows for air to enter and exit the NJK Sensor Flow Frame with smooth flow and dependable flow readings. Always place the NJK Sensor Flow Frame more centered (or forward) on the exterior wall opening.

19

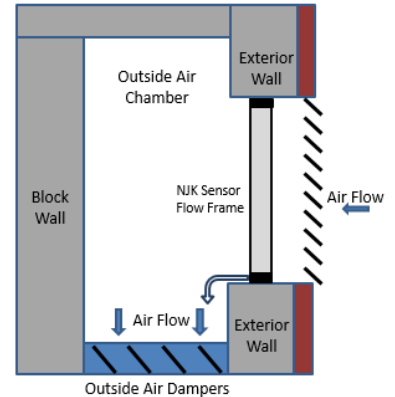

Right Angle Outside Air Inlet Mounting

Locate the NJK Flow Measuring Module on the Higher air velocity side of the NJK Sensor Flow Frame to allow the sensing probe to accurately measure the sampled air from the flow frame.

Note:- A 25% air velocity minimum or greater will allow for an open consideration when locating the NJK Flow Measuring Module. System Effects must be considered when locating the NJK Sensor Module. Any installation where placement of the module is in an area with an air flow velocity below 25% of the average velocity can not be guaranteed for accuracy and signal dependability.

20

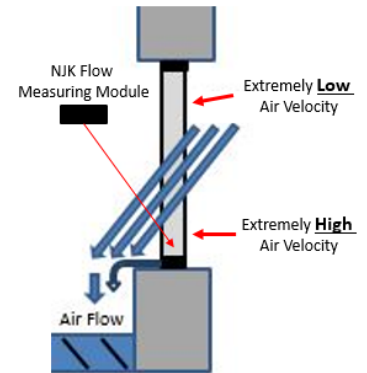

Air Handler Inlet / Outlet Mounting

In the application below the NJK Sensor Flow Frame can be installed in the air handler floor grating or ceiling take off directly with little or no ductwork leading into or out of the NJK Sensor Flow Frame. The ductwork entering or leaving the air handler must be the full size of the opening and the NJK Flow Frame to eliminate air being passed through a single portion of the NJK Flow Frame and offering an altered sampling of air flow.

21

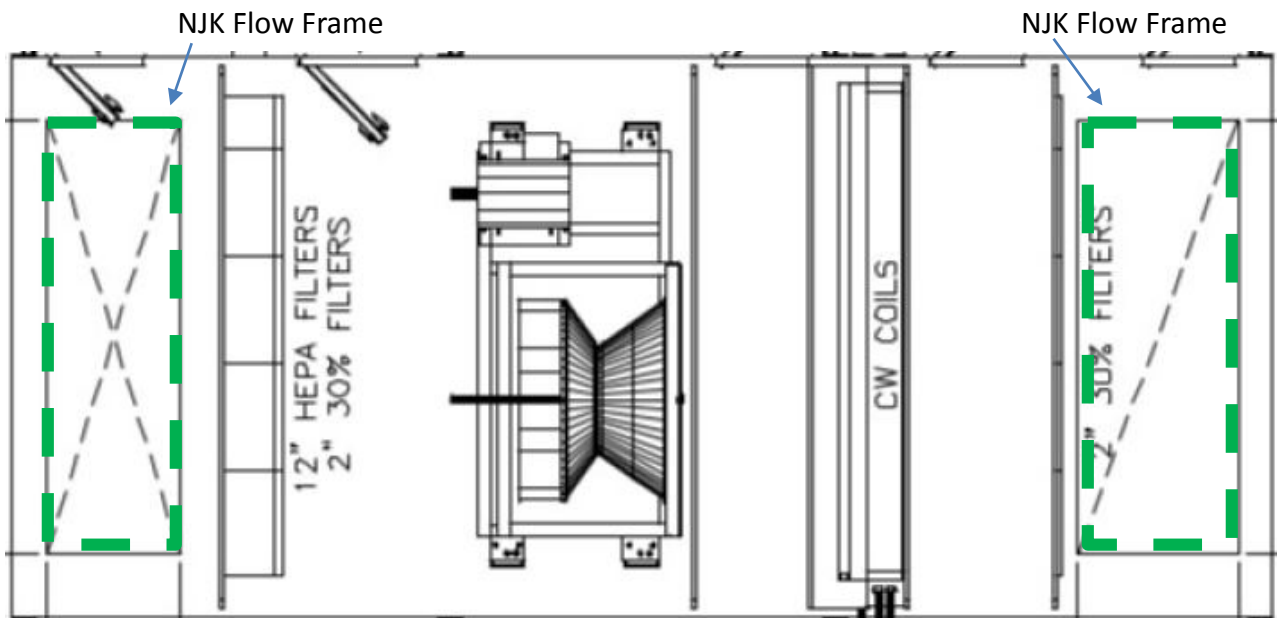

NJK-02 - Location and Mounting: Examples

Air Handler Inlet Mounting

Air handler inlet damper sections cannot be utilized to accurately measure airflow if all ductwork feeding air into the air handler is not the full size of the Outside Air Inlet damper section.

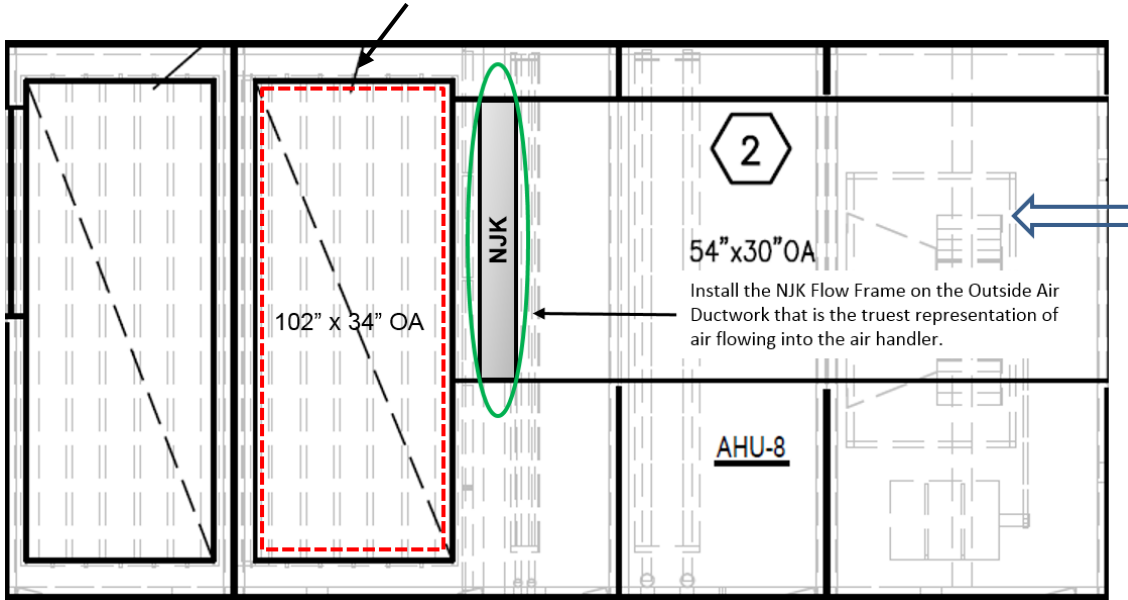

Air Handler Inlet Mounting

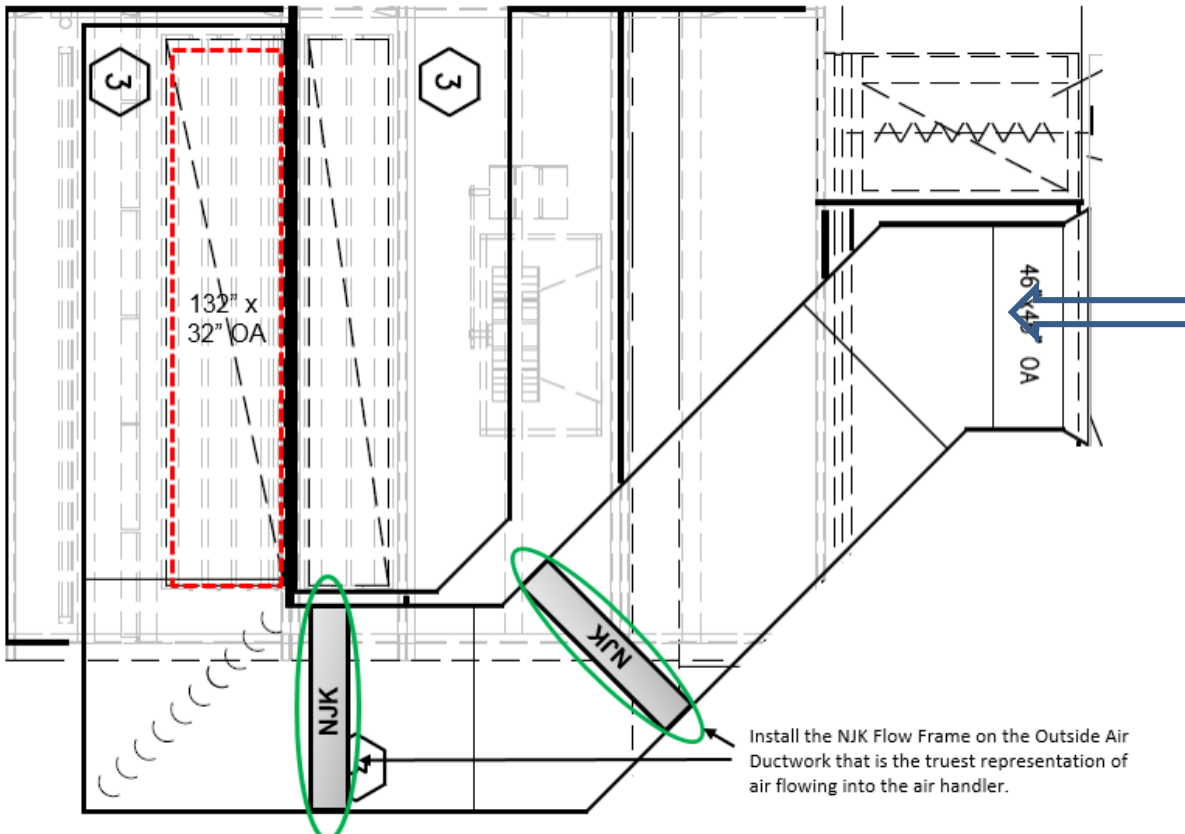

NJK-02 - Location and Mounting: Examples

Centrifugal Fan Plenum Mounting

In a supply plenum with a large (or multiple) Centrifugal Fans feeding the air into the supply plenum that air is distributed unevenly throughout the supply plenum and can also have strong cross flows of air across the face any of the supply duct take offs .

In this application the NJK Flow Frame can NOT be installed without ductwork leading into the sensor and the NJK Flow Frame will need to be installed further downstream in each of the individual duct runs (minimum of 2 duct diameters).

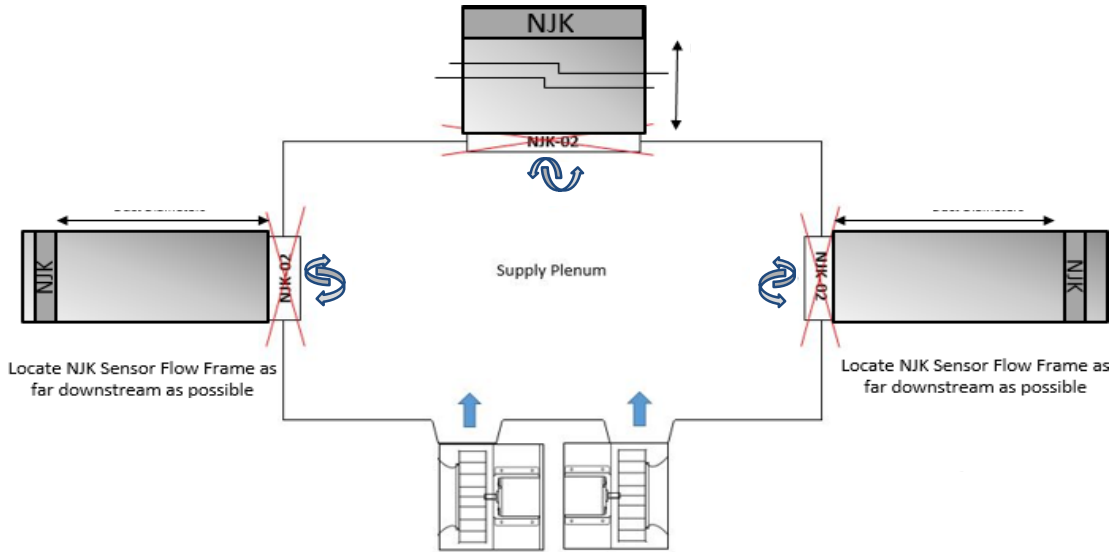

24

Right Angle Plenum Mounting

In a supply plenum with a Supply Fan feeding air at a right angle into the supply plenum the air will be turbulent as it changes flow direction.

In this application the NJK Sensor Flow Frame can NOT be installed without some lengths of straight ductwork (2 duct diameters minimum) leading into the sensor and the NJK Sensor Flow Frame will need to be installed further downstream in the straight duct lengths.

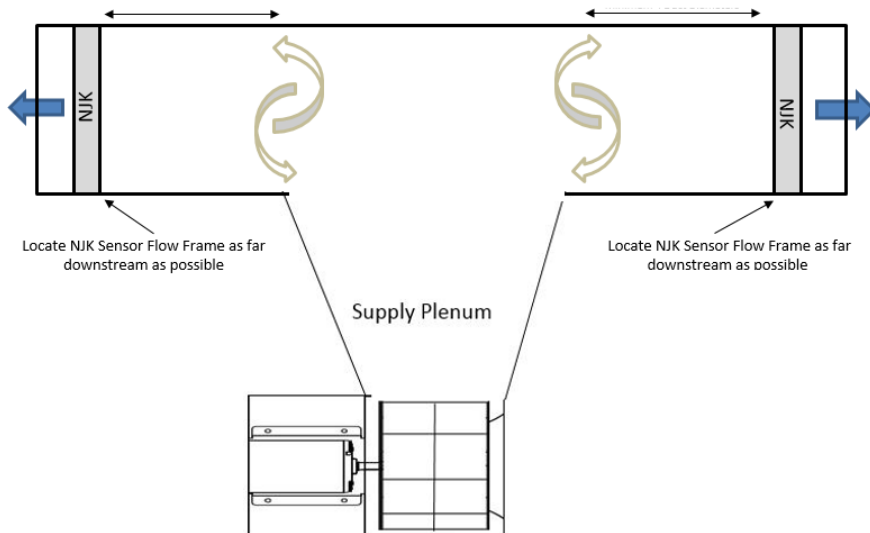

25

NJK-02 - Location and Mounting: Examples

Angled Duct Inlet Mounting

In an angled duct application, Locate NJK Sensor Flow Frame at the end of the duct run prior to the duct angle transition (1), or Locate the NJK Sensor Flow Frame a minimum of 2 duct diameters downstream of the angled duct area (2).

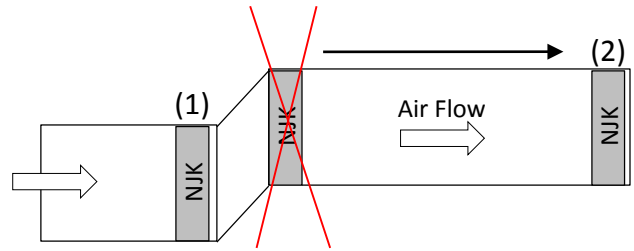

26

Tapered Duct Inlet Mounting

In this tapered duct application, Locate NJK Sensor Flow Frame at the end of the duct run prior to the duct transition (1), or Locate the NJK Sensor Flow Frame a minimum of 2 duct diameters downstream of the tapered duct area (2).

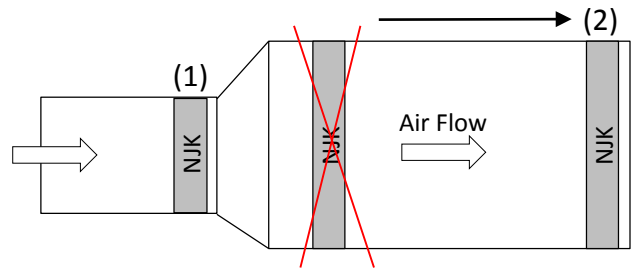

27

Tapered Duct Inlet Mounting

In this tapered duct application, Locate NJK Sensor Flow Frame at the end of the duct run prior to the duct transition (1), or Locate the NJK Sensor Flow Frame a minimum of 2 duct diameters downstream of the tapered duct area (2).

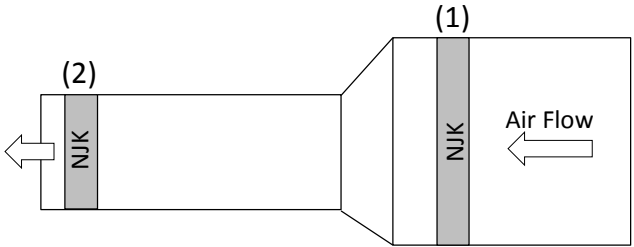

28

Tapered Supply Plenum

In a supply plenum with a large Centrifugal Fan feeding air into the supply plenum tapered "bellmouth" the air will be turbulent. The tapered section of ductwork can allow supplied air to be forced through the center of the duct bypassing some of the sampled air from the NJK-02 Perimeter Sampling Flow Frame.

In this application the NJK Sensor Flow Frame can NOT be installed without some lengths (minimum 2 duct diameters) of straight ductwork leading into the sensor and the NJK Sensor Flow Frame will need to be installed further downstream in that straight duct length.

This installation will have a very unstable flow reading through the NJK Sensor Flow Frame as the flow off from each blade of the centrifugal fan will have an impact on the sensor reading.

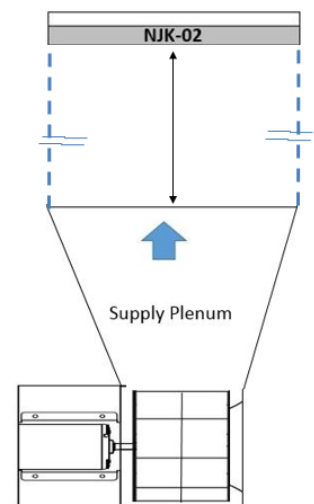

29

NJK-02 - Location and Mounting: Examples

Multiple Take-Off Branch Mounting

In the Multiple Take-Off mounting installation below the NJK Sensor Flow Frames are to be mounted in more than one branch duct connections from the main plenum. In a Supply Air Plenum the air will be turbulent as it enters the branch duct connections. Mount the NJK Flow Frame a minimum of 2 duct diameters downstream from the main plenum.

Install sensors downstream on the inlet of the VAV Box. This will allow the NJK Sensors to accurately read flow at the VAV Box and will be out of the turbulent air at the branch duct connections to the main plenum.

